

Control valve(3/2way)

M3 Series

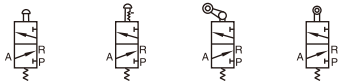

Symbol



Product feature

- Exhaust outlet locates over the (body), which is convenient to install muffler to decrease noise and pollution.
- The external force required by direction-change of series of M3B, M3R and M3L is provided by external mechanism, which can be used for position test or stroke switch] limit switch.
- M3C, M3D, M3Y, M3PF, M3PM, M3PP, M3PL and M3HS are operated manually, owning control joints with several structure forms and suitable for application under different conditions.
- It is in sliding column structure that the control force is not influenced by working pressure (that is, there is no back pressure effect); internal circle is sealed with good tightness and the direction-change is sensitive.
- No need to add oil for lubrication.
- Multi-mounting makes it convenient to install and apply;
- The control joints of series of M3C, M3D, M3Y, M3R, and M3L are made of metal which has long service life and more reliable and steady performance.

Inner structure

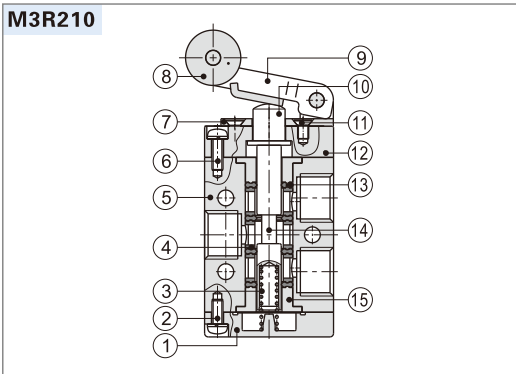

| No. | Item | No. | Item | No. | Item |
|-----|--------------|-----|----------------|-----|-------------------|
| 1 | Bottom cover | 6 | Screw | 11 | Screw |
| 2 | Screw | 7 | Roller holder | 12 | Fore cover |
| 3 | Spring | 8 | Roller | 13 | Piston O-ring |
| 4 | Spacer | 9 | Rotating block | 14 | Spool |
| 5 | Body | 10 | Axle | 15 | Positioning block |

Flow chart

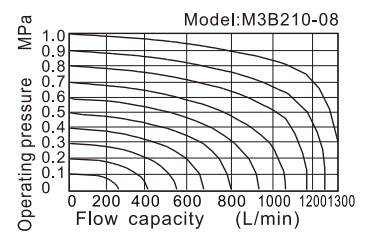
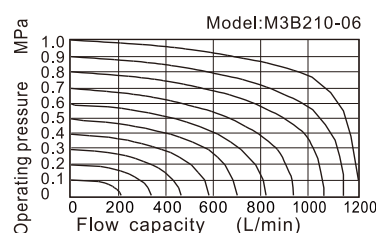
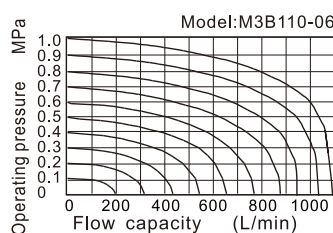
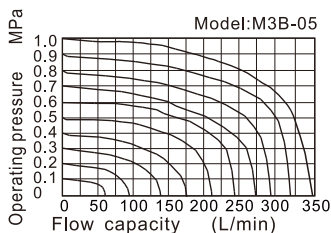

Specification

| Model | M3B | M3C | M3D | M3R | M3L | M3Y | M3PM | M3PP | M3PF | M3PL | M3HS |
|---------------------|--|-----|-----|-----|-----|--|------|------|------|------|------|
| Fluid | Air (to be filtered by 40 μm filter element) | | | | | | | | | | |
| Operating | External control direct acting type | | | | | | | | | | |
| Port size [Note1] | 05: M5 06: 1/8" 08: 1/4" | | | | | | | | | | |
| Orifice size | Mini type | | | | | 05: 2.5mm ² (Cv=0.14) | | | | | |
| | 110 | | | | | 06: 8.0mm ² (Cv=0.45) | | | | | |
| | 210 | | | | | 06: 9.0mm ² (Cv=0.50) 08: 12.0mm ² (Cv=0.67) | | | | | |
| Valve type | 3/2 Way | | | | | | | | | | |
| Lubrication [Note2] | Not required | | | | | | | | | | |
| Pressure range | 0~1.0MPa(0~145psi) | | | | | | | | | | |
| Proof pressure | 1.5MPa(215psi) | | | | | | | | | | |
| Temperature °C | -20~70 | | | | | | | | | | |
| Material body | Aluminum alloy | | | | | | | | | | |

[Note1] PT thread, G thread and NPT thread are available.

[Note2] Once lubricated air is used, continue with same medium to optimise valve life span. It is suggested to use ISO VG32 lubricant or the oil with the same grade.

Reversal stroke

| Common type | | | | | | Mini type | | |
|-------------|--------------|---------------|------|--------------|-----------------------|-----------|--------------|---------------|
| Type | Spool stroke | Button stroke | Type | Spool stroke | Roller(handle) stroke | Type | Spool stroke | Roller stroke |
| M3B | 2.0~3.3 | - | M3R | 2.0~3.0 | 4.6~6.8 | M3B05 | 2.0~3.3 | - |
| M3PF | 2.0~3.3 | 3.8~5.1 | M3L | 2.0~3.0 | 5.0~7.8 | M3R05 | 2.0~3.0 | 6.0~8.5 |
| M3PP | 2.0~3.3 | 3.8~5.1 | M3C | 2.0~3.0 | 11.0~16.0 | M3L05 | 2.0~3.0 | 7.0~10.0 |
| M3PM | 2.0~3.3 | 3.8~5.1 | M3D | 2.0~3.0 | 5.5~8.0 | | | |
| M3PL | 2.0~3.3 | 5.9~7.2 | | | | | | |
| M3HS | 2.0~3.3 | 5.1~6.4 | | | | | | |

Ordering code

Common type **M3 PM 210 06 R □**

① ② ③ ④ ⑤ ⑥

| ① Valve's type | ② Model | ③ Code | ④ Port size | ⑤ Button color | ⑥ Thread |
|-----------------------|---------------------------------|--------------------------------------|----------------------|--------------------------------|-----------------------------|
| M3: M type 3/2 Way | B: Basic type | 110: 100 Series single control | 06: 1/8" | No this code | Blank: PT G: G T: NPT |
| | C: Long handle type | | | | |
| | D: Short handle type | | | | |
| | Y: Lever type | | | | |
| | R: Roller type | 210: 200 Series single control | 06: 1/8" 08: 1/4" | R: Red | |
| | L: Roller with free return type | | | R: Red G: Green B: Black | |
| | PL: Latching type | | | | |
| | PP: Protruding type | | | | |
| | PF: Flat type | | | | |
| | PM: Mushroom type | | | | |
| HS: Selector type | | | | | |

Mini type

Mini type **M3 R 05**

① ② ③

| ① Valve's type | ② Model | ③ Port size |
|--------------------|--|-------------|
| M3: M type 3/2 Way | B: Basic type R: Roller type L: Roller with free return type | 05: M5 |

Control valve(3/2way)

M3 Series

Installation and Application

- 1) Body and panel installation (picture at right) :
- 2)The control set is made of engineering plastic which only allows manual operation and switching valves through metal impact is forbidden.
- 3)The series of M3B, M3C, M3D, M3PM, M3PF and M3PP get the function of automatic restoration. The hand valves of M3Y, M3HS and M3PL are in the type of manual restoration.M3PL will be restored by turning the revolve button after being pressed into orientation.
- 4) Pay attention to the reversing stroke. The reversing stroke can not surpass its stroke stipulated in stroke control table when the direction-change of the valve is forced by any external forces, otherwise it will cause the damage of the valve.
- 5) The M3L can only switch the valve in single direction (impact from right to left). The impact from the other direction is invalid (from left to right).
- 6) Control joint combination can be ordered individually. Please refer to the table on the right for order details.

Fixation way of body

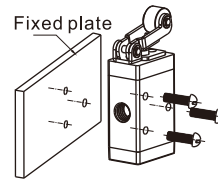

Fixation way of panel

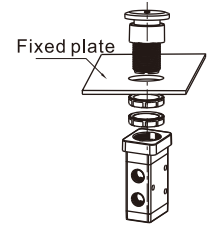

Dimensions

Common type

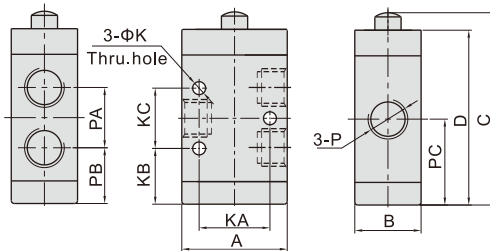

| Model\Item | A | B | C | D | K | KA | KB | KC | P | PA | PB | PC |
|------------|----|----|----|------|-----|------|------|----|------|----|------|------|
| M3B11006 | 27 | 18 | 52 | 46.5 | 3.3 | 18 | 15.5 | 16 | 1/8" | 16 | 15.5 | 23.5 |
| M3B21006 | 35 | 22 | 64 | 58 | 4.3 | 23.5 | 18.5 | 20 | 1/8" | 20 | 18.5 | 28.5 |
| M3B21008 | | | | | | | | | 1/4" | | | |

Mini type

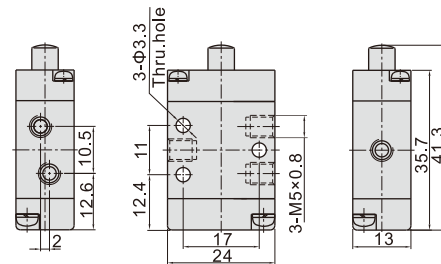

Roller type(R)

Mini type

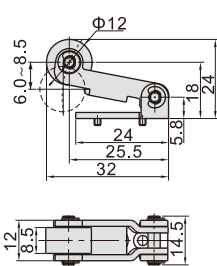

Common type

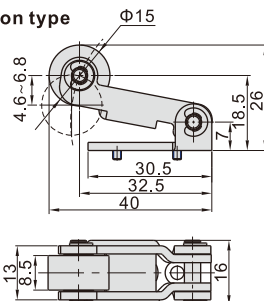

| Model | Roller type(R) | |
|---------------------|----------------|---|
| How to order | Ordering code | M3R05-P14A M3R210-P14A |
| | Type | M3R05 Roller type control set M3R210 Roller type control set |
| Applicable products | | M3R05 M3R110, M3R210 |

Roller with free return type(L)

Mini type

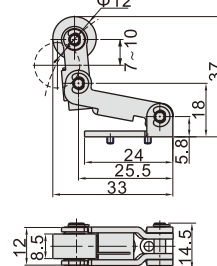

Common type

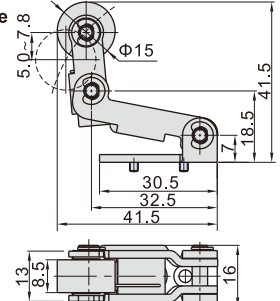

| Model | Roller with free return type(L) | |
|---------------------|---------------------------------|---|
| How to order | Ordering code | M3L05-P14A M3L210-P14A |
| | Type | M3L05 Roller with free return type control set M3L210 Roller with free return type control set |
| Applicable products | | M3L05 M3L110, M3L210 |

Short handle type(D)

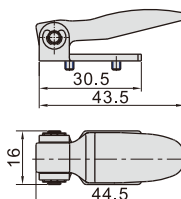

| Model | Short handle type(D) | |
|---------------------|----------------------|--------------------------------------|
| How to order | Ordering code | M3D210-P13A |
| | Type | M3D210 Short handle type control set |
| Applicable products | | M3D110, M3D210 |

Long handle type(C)

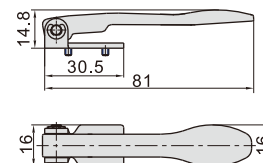

| Model | Long handle type(C) | |
|---------------------|---------------------|-------------------------------------|
| How to order | Ordering code | M3C210-P13A |
| | Type | M3C210 Long handle type control set |
| Applicable products | | M3C110, M3C210 |

Control valve(3/2way)

M3 Series

Lever type(Y)

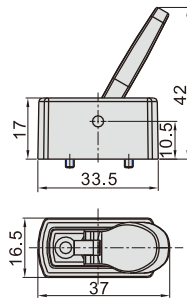

| Model | | Lever type(Y) |
|---------------------|---------------|-------------------------------|
| How to order | Ordering code | M3Y210-P13A |
| | Type | M3Y210 Lever type control set |
| Applicable products | | M3Y110, M3Y210 |

Latching type(PL)

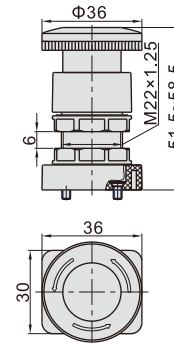

| Model | | Latching type (only red)(PL) |
|---------------------|---------------|--------------------------------------|
| How to order | Ordering code | S3PL05-P12A |
| | Type | S3PL Latching type control set (Red) |
| Applicable products | | M3PL110, M3PL210 |

Mushroom type(PM)

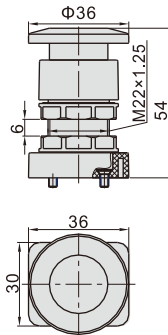

| Model | | Mushroom type(PM) |
|---------------------|---------------|--|
| How to order | Ordering code | S3PM05-P11A |
| | Type | S3PM mushroom type control set (Green) |
| | Ordering code | S3PM05-P12A |
| | Type | S3PM mushroom type control set (Red) |
| Applicable products | Ordering code | S3PM05-P13A |
| | Type | S3PM mushroom type control set (Black) |
| Applicable products | | M3PM110, M3PM210 |

Protruding type(PP)

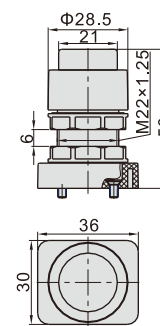

| Model | | Protruding type(PP) |
|---------------------|---------------|--|
| How to order | Ordering code | S3PP05-P11A |
| | Type | S3PP protruding type control set (Green) |
| | Ordering code | S3PP05-P12A |
| | Type | S3PP protruding type control set (Red) |
| Applicable products | Ordering code | S3PP05-P13A |
| | Type | S3PP protruding type control set (Black) |
| Applicable products | | M3PP110, M3PP210 |

Flat type(PF)

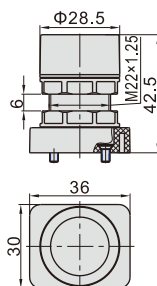

| Model | | Flat type(PF) |
|---------------------|---------------|------------------------------------|
| How to order | Ordering code | S3PF05-P11A |
| | Type | S3PF flat type control set (Green) |
| | Ordering code | S3PF05-P12A |
| | Type | S3PF flat type control set (Red) |
| Applicable products | Ordering code | S3PF05-P13A |
| | Type | S3PF flat type control set (Black) |
| Applicable products | | M3PF110, M3PF210 |

Selector type(HS)

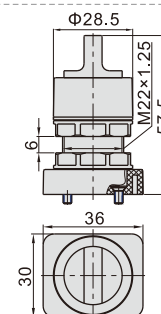

| Model | | Selector type(HS) |
|---------------------|---------------|--|
| How to order | Ordering code | S3HS05-P11A |
| | Type | S3HS selector type control set (Green) |
| | Ordering code | S3HS05-P12A |
| | Type | S3HS selector type control set (Red) |
| Applicable products | Ordering code | S3HS05-P13A |
| | Type | S3HS selector type control set (Black) |
| Applicable products | | M3HS110, M3HS210 |